

1T7852EL | OZ Stand Alone Trimless Recessed trimless LED floodlights

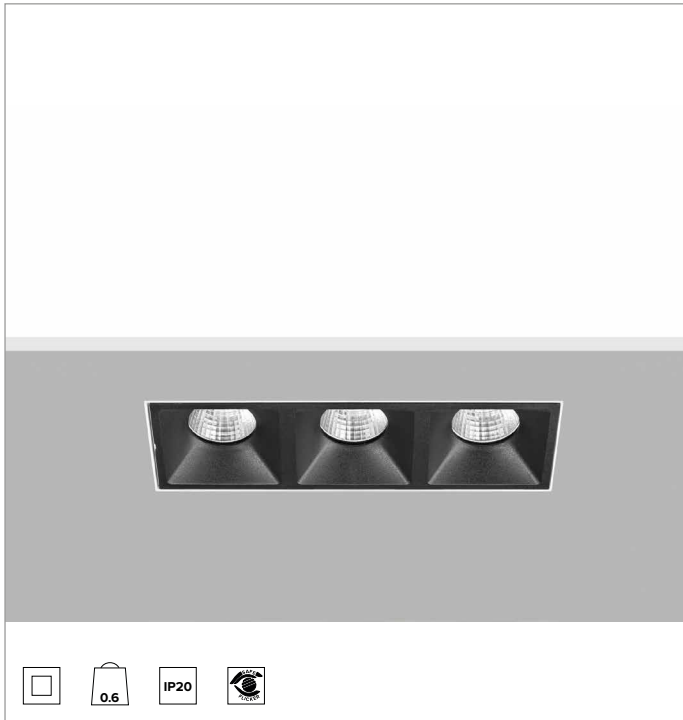

	3500K	H(m)	D(m)	Emax(lx)
	Ra90		50°	
Fixture Power	19W	1	0.93	3409
Source Flux	2718lm	2	1.85	852
Fixture Flux	2103lm	3	2.78	379
Efficacy	109lm/W	4	3.71	213
TS1196	Imax=1254cd/klm	Imax	3409cd	5
			4.64	136

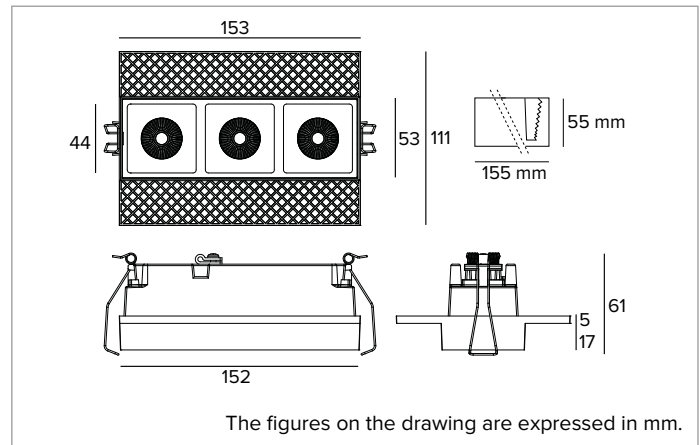

SOURCE

High efficiency Chip on Board LED Ra90.

Energy efficiency class: E

Nominal power: 17W

Nominal flux: 2718lm

Colour rendering index: 90

Rf: 91

Rg: 100

CCT nominal: 3500K

SDCM: 2

Lifetime (L80/B10): >50000h tq +25°C

ILLUMINOTECHNICAL CHARACTERISTICS

MWFL optic. Anodised aluminium reflector and black polycarbonate frame. The light is suitable for installation in work environments UGR<17 (EN12464-1).

Optic: REFLECTOR

Beam angles: MWFL

Optical efficiency: 77%

Fixture flux: 2103lm

Luminous efficacy: 109lm/W

Photobiological safety: Compliant with RG1 low risk group

MECHANICAL CHARACTERISTICS

Black die-cast anodised aluminium frame. 3X Large version.

Dimensions: AxB=153x53mm

Weight: 0.6Kg

Version: 3X

Degree of protection: IP20

ELECTRICAL CHARACTERISTICS

Complete with an electronic ON-OFF driver. Luminaire compliant with EN 60598-2-22 for power supply from a centralised emergency system CPSS (Central Power Supply System), not incorporated in the luminaire - high risk areas excluded. The default power and flux are 100% in AC and 100% in DC.

Fixture Power: 19W

Power supply: 220-240Vac 50/60Hz

Insulation Class: CLASS 2

Type of driver / Control: ON-OFF

Driver included: YES

Class F: YES

SAFE FLICKER: PstLM=<1 and SVM=<0.4 (IEC TR 61547-1 and IEC TR 63158), to ensure a more comfortable and safe light

Ambient temperature: 0°C / +25°C

INSTALLATION

Trimless installation system suitable for plasterboard panels, 13, 15, and 17mm.

NOTES

110-277Vac version available on request.

WARRANTY

5 years.

WARNING

Luminaire designed for disposal/recycling at end-of-life. Replaceable (LED only) light source by a professional. Replaceable control gear by a professional.

Due to the technological evolution of the electronic components, the data provided may be updated, and as such, confirmation must be requested during the order process.

Luminous flux and power supply have +/-10% tolerances with respect to the indicated value. tq +25°C (CIE 121).

We reserve the right to make technical changes.

Targetti Sankey S.r.l.
Via Pratese, 164
50145 Firenze - Italy
Tel: +39 055 37911
targetti.com
targetti@targetti.com

CCIAA Firenze
Share Capital:
€ 500.000,00
VAT N. (IT):
01537660480
R.E.A: FI-275656

TARGETTI

1T7852EL | OZ Stand Alone Trimless Recessed trimless LED floodlights

Accessories

Emergency Kit



Code

A059

Emergency kit composed of an inverter a LiFePO4 battery and a LED Green indicator.
Allows permanent EP emergency use of the fixture it is connected to.

The 1h or 3h autonomy can be selected by configuring the fixture.

The batteries take 12h to completely recharge.

LED Green indicator wired to the inverter through single-core cables L= 800mm.

Emergency kit for fixtures that comply with EN 60598-2-22 standard, high risk areas excluded.

Battery size 160x54x30 mm.

Inverter size 165x40x25 mm.

Due to the technological evolution of the electronic components, the data provided may be updated, and as such, confirmation must be requested during the order process.

Luminous flux and power supply have +/-10% tolerances with respect to the indicated value. tq +25°C (CIE 121).

We reserve the right to make technical changes.

Targetti Sankey S.r.l.
Via Pratese, 164
50145 Firenze - Italy
Tel: +39 055 37911
targetti.com
targetti@targetti.com

CCIAA Firenze
Share Capital:
€ 500.000,00
VAT N. (IT):
01537660480
R.E.A: FI-275656

TARGETTI